



**Dual Sockets**

*THIN WALL sockets designed for*  
**BOTH IMPACT & HAND USE**

**HAVE IT  
BOTH WAYS**

With Dual Action™ Sockets buy only  
one socket series for impact tool and hand use



**ACTION TOOLS CORP.**

Mail: P.O. Box 1654, Taichung, Taiwan, R.O.C.  
Factory: No.82, Lane 352, Kwang Fu Road, Kwang  
Fu Li, Situn District, Taichung 40760, Taiwan, R.O.C  
Tel: 886-4-24250300 Fax: 886-4-24250025  
E-mail: [action@ms10.hinet.net](mailto:action@ms10.hinet.net)  
[www.actiontools.com.tw](http://www.actiontools.com.tw)

MAR. 15. 1000  
ACH-1501





## Professional Dual Purpose Sockets

Specifically engineered for the needs of the professional technician, Dual Action™ sockets and accessories provide unparalleled versatility by allowing easy switching between the precision and access of a hand tool with the power of air and cordless impact tools.

Recessed quick release button prevents accidental release of the socket.



Wobble extensions provide 15° of deflection and can also be locked straight for normal use.

Low profile ratchet design allows greater access to confined areas and will not catch on items in the work area.



The thin wall design of chrome hand sockets combined with the strength of Impact Sockets creates the Professional Dual Action™ Socket Series. With a Dual Action™ you really are ready for action.

SAVE YOURSELF TIME, MONEY AND VALUABLE SPACE IN YOUR GARAGE.

# Index

Description	Drive Size	Page
6 & 12 Point Dual Action Socket Sets	1/4" Drive	1-3
	3/8" Drive	4-6
	1/2" Drive	7-10
6 Point Dual Action Socket Sets On Metal Rails	1/4" Drive	11
	3/8" Drive	11
	1/2" Drive	12
6 & 12 Point Fractional & Metric Dual Action Sockets	1/4" Drive	13-14
	3/8" Drive	15-16
	1/2" Drive	17-20
Extension Bars & Wobble Spinner Handle		21
Ratchet Handle With Quick Release & Repair Kits		22
Universal Joints & Adaptors		23
Quick-Change Extension Bars & 3/8" Drive Spark Plug Sockets		24

## No. 10043102 31 Piece 1/4" Drive 6-Point Metric Standard & Deep Socket Set



**1/4" 6 31 Piece Set Contents:**

14 Piece Metric Standard Length:

4mm, 4.5mm, 5mm, 5.5mm, 6mm, 7mm, 8mm,  
9mm, 10mm, 11mm, 12mm, 13mm, 14mm, 15mm

14 Piece Metric Deep Length:

4mm, 4.5mm, 5mm, 5.5mm, 6mm, 7mm, 8mm,  
9mm, 10mm, 11mm, 12mm, 13mm, 14mm, 15mm

72 Tooth Ratchet Handle with Quick release button

50mm(2") Extension bar

150mm(6") Extension bar

Blow-Mold Case

## No. 10045302 53 Piece 1/4" Drive 6-Point Fractional & Metric Socket Set



**1/4" 6 53 Piece Set Contents:**

10 Piece Fractional Standard Length:

3/16", 7/32", 1/4", 9/32", 5/16",  
11/32", 3/8", 7/16", 1/2", 9/16"

10 Piece Fractional Deep Length:

3/16", 7/32", 1/4", 9/32", 5/16",  
11/32", 3/8", 7/16", 1/2", 9/16"

14 Piece Metric Standard Length:

4mm, 4.5mm, 5mm, 5.5mm, 6mm, 7mm, 8mm,  
9mm, 10mm, 11mm, 12mm, 13mm, 14mm, 15mm

14 Piece Metric Deep Length:

4mm, 4.5mm, 5mm, 5.5mm, 6mm, 7mm, 8mm,  
9mm, 10mm, 11mm, 12mm, 13mm, 14mm, 15mm

72 Tooth Ratchet Handle with Quick release button

50mm(2") Extension bar

100mm(4") Extension bar

150mm(6") Extension bar

150mm(6") Wobble Spinner Handle

Blow-Mold Case



## No. 12042302 23 Piece 1/4" Drive 6-Point Fractional Standard & Deep Socket Set



1/4"

6

23 Piece Set Contents:

10 Piece Fractional Standard Length:

3/16", 7/32", 1/4", 9/32", 5/16",  
11/32", 3/8", 7/16", 1/2", 9/16"

10 Piece Fractional Deep Length:

3/16", 7/32", 1/4", 9/32", 5/16",  
11/32", 3/8", 7/16", 1/2", 9/16"

72 Tooth Ratchet Handle with Quick release button

50mm(2") Extension bar

150mm(6") Extension bar

Blow-Mold Case

## No. 14043102 31 Piece 1/4" Drive 12-Point Metric Standard & Deep Socket Set



1/4"

12

31 Piece Set Contents:

14 Piece Metric Standard Length:

4mm, 4.5mm, 5mm, 5.5mm, 6mm, 7mm, 8mm  
9mm, 10mm, 11mm, 12mm, 13mm, 14mm, 15mm

14 Piece Metric Deep Length:

4mm, 4.5mm, 5mm, 5.5mm, 6mm, 7mm, 8mm  
9mm, 10mm, 11mm, 12mm, 13mm, 14mm, 15mm

72 Tooth Ratchet Handle with Quick release button

50mm(2") Extension bar

150mm(6") Extension bar

Blow-Mold Case

## No. 14045302 53 Piece 1/4" Drive 12-Point Fractional & Metric Socket Set



**1/4"** **12** 53 Piece Set Contents:

- 10 Piece Fractional Standard Length:  
3/16", 7/32", 1/4", 9/32", 5/16",  
11/32", 3/8", 7/16", 1/2", 9/16"
- 10 Piece Fractional Deep Length:  
3/16", 7/32", 1/4", 9/32", 5/16",  
11/32", 3/8", 7/16", 1/2", 9/16"
- 14 Piece Metric Standard Length:  
4mm, 4.5mm, 5mm, 5.5mm, 6mm, 7mm, 8mm,  
9mm, 10mm, 11mm, 12mm, 13mm, 14mm, 15mm
- 14 Piece Metric Deep Length:  
4mm, 4.5mm, 5mm, 5.5mm, 6mm, 7mm, 8mm,  
9mm, 10mm, 11mm, 12mm, 13mm, 14mm, 15mm
- 72 Tooth Ratchet Handle with Quick release button
- 50mm(2") Extension bar
- 100mm(4") Extension bar
- 150mm(6") Extension bar
- 150mm(6") Wobble Spinner Handle
- Blow-Mold Case

## No. 16042302 23 Piece 1/4" Drive 12-Point Fractional Standard & Deep Socket Set



**1/4"** **12** 23 Piece Set Contents:

- 10 Piece Fractional Standard Length:  
3/16", 7/32", 1/4", 9/32", 5/16",  
11/32", 3/8", 7/16", 1/2", 9/16"
- 10 Piece Fractional Deep Length:  
3/16", 7/32", 1/4", 9/32", 5/16",  
11/32", 3/8", 7/16", 1/2", 9/16"
- 72 Tooth Ratchet Handle with Quick release button
- 50mm(2") Extension bar
- 150mm(6") Extension bar
- Blow-Mold Case



## No. 10143501 35 Piece 3/8" Drive 6-Point Metric Standard & Deep Socket Set



**3/8"** **6** 35 Piece Set Contents:

- 16 Piece Metric Standard Length:
  - 7mm, 8mm, 9mm, 10mm, 11mm, 12mm, 13mm, 14mm, 15mm, 16mm, 17mm, 18mm, 19mm, 20mm, 21mm, 22mm
- 16 Piece Metric Deep Length:
  - 7mm, 8mm, 9mm, 10mm, 11mm, 12mm, 13mm, 14mm, 15mm, 16mm, 17mm, 18mm, 19mm, 20mm, 21mm, 22mm
- 72 Tooth Ratchet Handle with Quick release button
- 75mm(3") Wobble Extension bar
- 150mm(6") Wobble Extension bar
- Blow-Mold Case

## No. 10145901 59 Piece 3/8" Drive 6-Point Fractional & Metric Socket Set



**3/8"** **6** 59 Piece Set Contents:

- 12 Piece Fractional Standard Length:
  - 5/16", 3/8", 7/16", 1/2", 9/16", 5/8", 11/16", 3/4", 13/16", 7/8", 15/16", 1"
- 12 Piece Fractional Deep Length:
  - 5/16", 3/8", 7/16", 1/2", 9/16", 5/8", 11/16", 3/4", 13/16", 7/8", 15/16", 1"
- 16 Piece Metric Standard Length:
  - 7mm, 8mm, 9mm, 10mm, 11mm, 12mm, 13mm, 14mm, 15mm, 16mm, 17mm, 18mm, 19mm, 20mm, 21mm, 22mm
- 16 Piece Metric Deep Length:
  - 7mm, 8mm, 9mm, 10mm, 11mm, 12mm, 13mm, 14mm, 15mm, 16mm, 17mm, 18mm, 19mm, 20mm, 21mm, 22mm
- 72 Tooth Ratchet Handle with Quick release button
- 75mm(3") Wobble Extension bar
- 150mm(6") Wobble Extension bar
- Blow-Mold Case

## No. 12142701 27 Piece 3/8" Drive 6-Point Fractional Standard & Deep Socket Set



**3/8"** **6** 27 Piece Set Contents:

12 Piece Fractional Standard Length:

5/16", 3/8", 7/16", 1/2", 9/16", 5/8",  
11/16", 3/4", 13/16", 7/8", 15/16", 1"

12 Piece Fractional Deep Length:

5/16", 3/8", 7/16", 1/2", 9/16", 5/8",  
11/16", 3/4", 13/16", 7/8", 15/16", 1"

72 Tooth Ratchet Handle with Quick release button  
75mm(3") Wobble Extension bar  
150mm(6") Wobble Extension bar  
Blow-Mold Case

## No. 14143501 35 Piece 3/8" Drive 12-Point Metric Standard & Deep Socket Set



**3/8"** **12** 35 Piece Set Contents:

16 Piece Metric Standard Length:

7mm, 8mm, 9mm, 10mm, 11mm, 12mm,  
13mm, 14mm, 15mm, 16mm, 17mm, 18mm,  
19mm, 20mm, 21mm, 22mm

16 Piece Metric Deep Length:

7mm, 8mm, 9mm, 10mm, 11mm, 12mm,  
13mm, 14mm, 15mm, 16mm, 17mm, 18mm,  
19mm, 20mm, 21mm, 22mm

72 Tooth Ratchet Handle with Quick release button  
75mm(3") Wobble Extension bar  
150mm(6") Wobble Extension bar  
Blow-Mold Case





## No. 14145901 59 Piece 3/8" Drive 12-Point Fractional & Metric Socket Set



**3/8"** **12** 59 Piece Set Contents:

12 Piece Fractional Standard Length:

5/16", 3/8", 7/16", 1/2", 9/16", 5/8",  
11/16", 3/4", 13/16", 7/8", 15/16", 1"

12 Piece Fractional Deep Length:

5/16", 3/8", 7/16", 1/2", 9/16", 5/8",  
11/16", 3/4", 13/16", 7/8", 15/16", 1"

16 Piece Metric Standard Length:

7mm, 8mm, 9mm, 10mm, 11mm, 12mm,  
13mm, 14mm, 15mm, 16mm, 17mm, 18mm,  
19mm, 20mm, 21mm, 22mm

16 Piece Metric Deep Length:

7mm, 8mm, 9mm, 10mm, 11mm, 12mm,  
13mm, 14mm, 15mm, 16mm, 17mm, 18mm,  
19mm, 20mm, 21mm, 22mm

72 Tooth Ratchet Handle with Quick release button  
75mm(3") Wobble Extension bar  
150mm(6") Wobble Extension bar  
Blow-Mold Case

## No. 16142701 27 Piece 3/8" Drive 12-Point Fractional Standard & Deep Socket Set



**3/8"** **12** 27 Piece Set Contents:

12 Piece Fractional Standard Length:

5/16", 3/8", 7/16", 1/2", 9/16", 5/8",  
11/16", 3/4", 13/16", 7/8", 15/16", 1"

12 Piece Fractional Deep Length:

5/16", 3/8", 7/16", 1/2", 9/16", 5/8",  
11/16", 3/4", 13/16", 7/8", 15/16", 1"

72 Tooth Ratchet Handle with Quick release button  
75mm(3") Wobble Extension bar  
150mm(6") Wobble Extension bar  
Blow-Mold Case



## No. 10242901 29 Piece 1/2" Drive 6-Point Metric Socket Set



**1/2"** **6** 29 Piece Set Contents:

26 Piece Metric Standard Length:

10mm, 11mm, 12mm, 13mm, 14mm, 15mm, 16mm,  
17mm, 18mm, 19mm, 20mm, 21mm, 22mm, 23mm,  
24mm, 25mm, 26mm, 27mm, 28mm, 29mm, 30mm,  
32mm, 33mm, 34mm, 35mm, 36mm

24 Tooth Ratchet Handle with Quick release button  
75mm(3") Wobble Extension bar  
150mm(6") Wobble Extension bar  
Blow-Mold Case

## No. 11242901 29 Piece 1/2" Drive 6-Point Metric Deep Socket Set



**1/2"** **6** 29 Piece Set Contents:

26 Piece Metric Deep Length:

10mm, 11mm, 12mm, 13mm, 14mm, 15mm, 16mm,  
17mm, 18mm, 19mm, 20mm, 21mm, 22mm, 23mm,  
24mm, 25mm, 26mm, 27mm, 28mm, 29mm, 30mm,  
32mm, 33mm, 34mm, 35mm, 36mm

24 Tooth Ratchet Handle with Quick release button  
75mm(3") Wobble Extension bar  
150mm(6") Wobble Extension bar  
Blow-Mold Case



## No. 12242201 22 Piece 1/2" Drive 6-Point Fractional Socket Set



**1/2"** **6** 22 Piece Set Contents:

19 Piece Fractional Standard Length:

3/8", 7/16", 1/2", 9/16", 5/8", 11/16", 3/4", 13/16",  
7/8", 15/16", 1", 1-1/16", 1-1/8", 1-3/16", 1-1/4",  
1-5/16", 1-3/8", 1-7/16", 1-1/2"

24 Tooth Ratchet Handle with Quick release button  
75mm(3") Wobble Extension bar  
150mm(6") Wobble Extension bar  
Blow-Mold Case

## No. 13242201 22 Piece 1/2" Drive 6-Point Fractional Deep Socket Set



**1/2"** **6** 22 Piece Set Contents:

19 Piece Fractional Deep Length:

3/8", 7/16", 1/2", 9/16", 5/8", 11/16", 3/4", 13/16",  
7/8", 15/16", 1", 1-1/16", 1-1/8", 1-3/16", 1-1/4",  
1-5/16", 1-3/8", 1-7/16", 1-1/2"

24 Tooth Ratchet Handle with Quick release button  
75mm(3") Wobble Extension bar  
150mm(6") Wobble Extension bar  
Blow-Mold Case

## No. 14242901 29 Piece 1/2" Drive 12-Point Metric Socket Set



**1/2"** **12** 29 Piece Set Contents:

26 Piece Metric Standard Length:

10mm, 11mm, 12mm, 13mm, 14mm, 15mm, 16mm,  
17mm, 18mm, 19mm, 20mm, 21mm, 22mm, 23mm,  
24mm, 25mm, 26mm, 27mm, 28mm, 29mm, 30mm,  
32mm, 33mm, 34mm, 35mm, 36mm

24 Tooth Ratchet Handle with Quick release button  
75mm(3") Wobble Extension bar  
150mm(6") Wobble Extension bar  
Blow-Mold Case

## No. 15242901 29 Piece 1/2" Drive 12-Point Metric Deep Socket Set



**1/2"** **12** 29 Piece Set Contents:

26 Piece Metric Deep Length:

10mm, 11mm, 12mm, 13mm, 14mm, 15mm, 16mm,  
17mm, 18mm, 19mm, 20mm, 21mm, 22mm, 23mm,  
24mm, 25mm, 26mm, 27mm, 28mm, 29mm, 30mm,  
32mm, 33mm, 34mm, 35mm, 36mm

24 Tooth Ratchet Handle with Quick release button  
75mm(3") Wobble Extension bar  
150mm(6") Wobble Extension bar  
Blow-Mold Case



## No. 16242201 22 Piece 1/2" Drive 12-Point Fractional Socket Set



**1/2"** **12** 22 Piece Set Contents:

19 Piece Fractional Standard Length:

3/8", 7/16", 1/2", 9/16", 5/8", 11/16", 3/4", 13/16",  
7/8", 15/16", 1", 1-1/16", 1-1/8", 1-3/16", 1-1/4",  
1-5/16", 1-3/8", 1-7/16", 1-1/2"

24 Tooth Ratchet Handle with Quick release button  
75mm(3") Wobble Extension bar  
150mm(6") Wobble Extension bar  
Blow-Mold Case

## No. 17242201 22 Piece 1/2" Drive 12-Point Fractional Deep Socket Set



**1/2"** **12** 22 Piece Set Contents:

19 Piece Fractional Deep Length:

3/8", 7/16", 1/2", 9/16", 5/8", 11/16", 3/4", 13/16",  
7/8", 15/16", 1", 1-1/16", 1-1/8", 1-3/16", 1-1/4",  
1-5/16", 1-3/8", 1-7/16", 1-1/2"

24 Tooth Ratchet Handle with Quick release button  
75mm(3") Wobble Extension bar  
150mm(6") Wobble Extension bar  
Blow-Mold Case



## No. 10041201 12 Piece 1/4" Drive 6-Point Metric Standard Socket Set

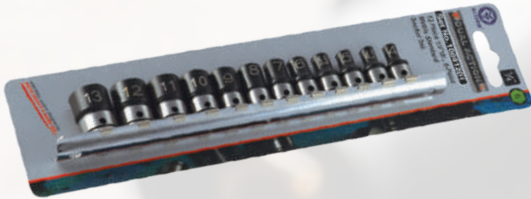

1/4"



12 Piece Set Contents:

12 Piece Metric Standard Length:

4mm, 4.5mm, 5mm, 5.5mm, 6mm, 7mm,  
8mm, 9mm, 10mm, 11mm, 12mm, 13mm

Sockets mounted on metal rail with clips

## No. 11041201 12 Piece 1/4" Drive 6-Point Metric Deep Socket Set

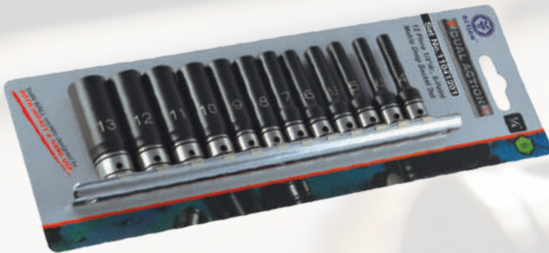

1/4"



12 Piece Set Contents:

12 Piece Metric Deep Length:

4mm, 4.5mm, 5mm, 5.5mm, 6mm, 7mm,  
8mm, 9mm, 10mm, 11mm, 12mm, 13mm

Sockets mounted on metal rail with clips

## No. 10141001 10 Piece 3/8" Drive 6-Point Metric Standard Socket Set

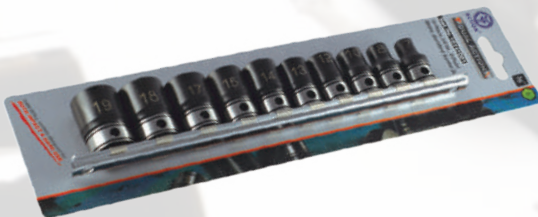

3/8"



10 Piece Set Contents:

10 Piece Metric Standard Length:

7mm, 8mm, 10mm, 12mm, 13mm,  
14mm, 15mm, 17mm, 18mm, 19mm

Sockets mounted on metal rail with clips

## No. 11141001 10 Piece 3/8" Drive 6-Point Metric Deep Socket Set

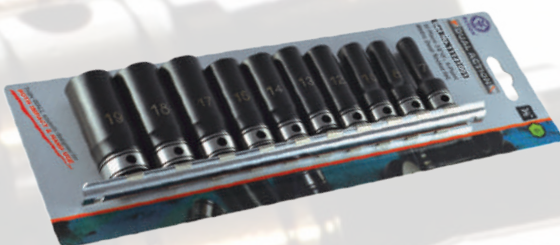

3/8"



10 Piece Set Contents:

10 Piece Metric Deep Length:

7mm, 8mm, 10mm, 12mm, 13mm,  
14mm, 15mm, 17mm, 18mm, 19mm

Sockets mounted on metal rail with clips



## No. 10241001 10 Piece 1/2" Drive 6-Point Metric Standard Socket Set

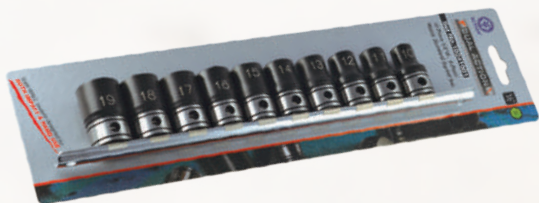

1/2"

6

10 Piece Set Contents:

10 Piece Metric Standard Length:

10mm, 11mm, 12mm, 13mm, 14mm,  
15mm, 16mm, 17mm, 18mm, 19mm

Sockets mounted on metal rail with clips

## No. 10241002 10 Piece 1/2" Drive 6-Point Metric Standard Socket Set



1/2"

6

10 Piece Set Contents:

10 Piece Metric Standard Length:

10mm, 12mm, 13mm, 14mm, 15mm,  
17mm, 19mm, 21mm, 22mm, 24mm

Sockets mounted on metal rail with clips

## No. 11241001 10 Piece 1/2" Drive 6-Point Metric Deep Socket Set

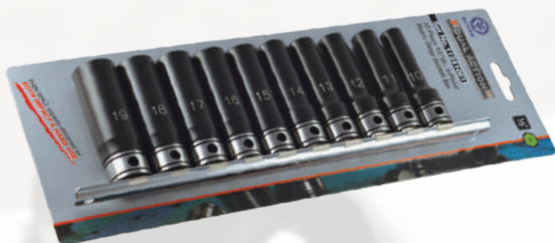

1/2"

6

10 Piece Set Contents:

10 Piece Metric Deep Length:

10mm, 11mm, 12mm, 13mm, 14mm,  
15mm, 16mm, 17mm, 18mm, 19mm

Sockets mounted on metal rail with clips

## No. 11241002 10 Piece 1/2" Drive 6-Point Metric Deep Socket Set



1/2"

6

10 Piece Set Contents:

10 Piece Metric Deep Length:

10mm, 12mm, 13mm, 14mm, 15mm,  
17mm, 19mm, 21mm, 22mm, 24mm.

Sockets mounted on metal rail with clips

1/4"



## 1/4" Drive 6-Point Fractional & Metric Sockets

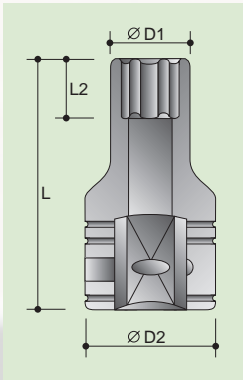

	D2	D1	L2	L	Standard	L2	L	Deep
size	mm	mm	mm	mm	Order No.	mm	mm	Order No.
3/16"	12	7.5	5	23	1204006	5	50	1304006
7/32"	12	8.5	6	23	1204007	6	50	1304007
1/4"	12	9.5	7	23	1204008	7	50	1304008
9/32"	12	10.5	7	23	1204009	7	50	1304009
5/16"	12	11.5	8	23	1204010	8	50	1304010
11/32"	12	13	9	23	1204011	9	50	1304011
3/8"	14	14.5	9	23	1204012	10	50	1304012
7/16"	15	16	9	23	1204014	11	50	1304014
1/2"	17	17.5	9	23	1204016	13	50	1304016
9/16"	18	19	11	25	1204018	16	50	1304018
4mm	12	6.5	5	23	1004040	5	50	1104040
4.5mm	12	7	5	23	1004045	5	50	1104045
5mm	12	7.5	5	23	1004050	5	50	1104050
5.5mm	12	8.5	6	23	1004055	6	50	1104055
6mm	12	9.5	7	23	1004060	7	50	1104060
7mm	12	10.5	7	23	1004070	7	50	1104070
8mm	12	11.5	8	23	1004080	8	50	1104080
9mm	12	13	9	23	1004090	9	50	1104090
10mm	14	14.5	9	23	1004100	10	50	1104100
11mm	15	16	9	23	1004110	11	50	1104110
12mm	16	17	9	23	1004120	13	50	1104120
13mm	17	18	9	23	1004130	13	50	1104130
14mm	18	19	11	25	1004140	16	50	1104140
15mm	19	20	11	25	1004150	16	50	1104150



Standard



Deep





1/4"

12

## 1/4" Drive 12-Point Fractional & Metric Sockets

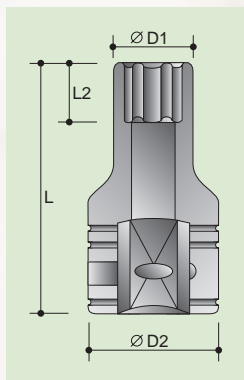

size	D2 mm	D1 mm	L2 mm	L mm	Standard Order No.	L2 mm	L mm	Deep Order No.
3/16"	12	7.5	5	23	1604006	5	50	1704006
7/32"	12	8.5	6	23	1604007	6	50	1704007
1/4"	12	9.5	7	23	1604008	7	50	1704008
9/32"	12	10.5	7	23	1604009	7	50	1704009
5/16"	12	11.5	8	23	1604010	8	50	1704010
11/32"	12	13	9	23	1604011	9	50	1704011
3/8"	14	14.5	9	23	1604012	10	50	1704012
7/16"	15	16	9	23	1604014	11	50	1704014
1/2"	17	17.5	9	23	1604016	13	50	1704016
9/16"	18	19	11	25	1604018	16	50	1704018
4mm	12	6.5	5	23	1404040	5	50	1504040
4.5mm	12	7	5	23	1404045	5	50	1504045
5mm	12	7.5	5	23	1404050	5	50	1504050
5.5mm	12	8.5	6	23	1404055	6	50	1504055
6mm	12	9.5	7	23	1404060	7	50	1504060
7mm	12	10.5	7	23	1404070	7	50	1504070
8mm	12	11.5	8	23	1404080	8	50	1504080
9mm	12	13	9	23	1404090	9	50	1504090
10mm	14	14.5	9	23	1404100	10	50	1504100
11mm	15	16	9	23	1404110	11	50	1504110
12mm	16	17	9	23	1404120	13	50	1504120
13mm	17	18	9	23	1404130	13	50	1504130
14mm	18	19	11	25	1404140	16	50	1504140
15mm	19	20	11	25	1404150	16	50	1504150



Standard



Deep

3/8"



## 3/8" Drive 6-Point Fractional & Metric Sockets

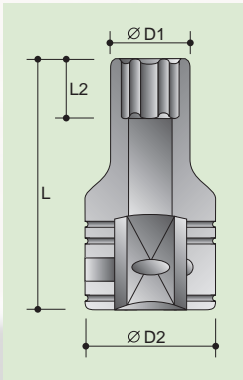

Standard



Deep

size	D2 mm	D1 mm	L2 mm	L mm	Standard Order No.	L2 mm	L mm	Deep Order No.
5/16"	17.3	12	6	30	1214010	8.5	55	1314010
3/8"	17.3	14.5	6	30	1214012	10	55	1314012
7/16"	17.3	16	8	30	1214014	11.5	55	1314014
1/2"	17.3	18	9	30	1214016	13	55	1314016
9/16"	18	20	11	32	1214018	16	55	1314018
5/8"	20	22	11	32	1214020	16	60	1314020
11/16"	22	23.5	11	32	1214022	19	60	1314022
3/4"	24	25	13	34	1214024	19	60	1314024
13/16"	26	27	15	34	1214026	19	60	1314026
7/8"	28	29	15	34	1214028	22	60	1314028
15/16"	30	31	16	34	1214030	25	60	1314030
1"	30	32	16	36	1214100	25	60	1314100
7mm	17.3	10.6	5	30	1014007	7	55	1114007
8mm	17.3	12	6	30	1014008	8.5	55	1114008
9mm	17.3	13	6	30	1014009	8.5	55	1114009
10mm	17.3	14.5	7	30	1014010	10	55	1114010
11mm	17.3	16	8	30	1014011	11.5	55	1114011
12mm	17.3	16.8	9	30	1014012	13	55	1114012
13mm	17.3	18	9	30	1014013	13	55	1114013
14mm	18	20	11	32	1014014	16	55	1114014
15mm	20	21	11	32	1014015	16	55	1114015
16mm	20	22	11	32	1014016	16	60	1114016
17mm	22	23.5	11	32	1014017	16	60	1114017
18mm	23	24.5	13	34	1014018	19	60	1114018
19mm	24	25	13	34	1014019	19	60	1114019
20mm	25	26	13	34	1014020	19	60	1114020
21mm	26	27	15	34	1014021	19	60	1114021
22mm	28	29	15	34	1014022	22	60	1114022



3/8"

12

## 3/8" Drive 12-Point Fractional & Metric Sockets

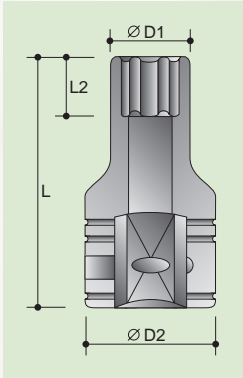

Standard



Deep

	D2	D1	L2	L	Standard	L2	L	Deep
size	mm	mm	mm	mm	Order No.	mm	mm	Order No.
5/16"	17.3	12	6	30	1614010	8.5	55	1714010
3/8"	17.3	14.5	6	30	1614012	10	55	1714012
7/16"	17.3	16	8	30	1614014	11.5	55	1714014
1/2"	17.3	18	9	30	1614016	13	55	1714016
9/16"	18	20	11	32	1614018	16	55	1714018
5/8"	20	22	11	32	1614020	16	60	1714020
11/16"	22	23.5	11	32	1614022	19	60	1714022
3/4"	24	25	13	34	1614024	19	60	1714024
13/16"	26	27	15	34	1614026	19	60	1714026
7/8"	28	29	15	34	1614028	22	60	1714028
15/16"	30	31	16	34	1614030	25	60	1714030
1"	30	32	16	36	1614100	25	60	1714100
7mm	17.3	10.6	5	30	1414007	7	55	1514007
8mm	17.3	12	6	30	1414008	8.5	55	1514008
9mm	17.3	13	6	30	1414009	8.5	55	1514009
10mm	17.3	14.5	7	30	1414010	10	55	1514010
11mm	17.3	16	8	30	1414011	11.5	55	1514011
12mm	17.3	16.8	9	30	1414012	13	55	1514012
13mm	17.3	18	9	30	1414013	13	55	1514013
14mm	18	20	11	32	1414014	16	55	1514014
15mm	20	21	11	32	1414015	16	55	1514015
16mm	20	22	11	32	1414016	16	60	1514016
17mm	22	23.5	11	32	1414017	16	60	1514017
18mm	23	24.5	13	34	1414018	19	60	1514018
19mm	24	25	13	34	1414019	19	60	1514019
20mm	25	26	13	34	1414020	19	60	1514020
21mm	26	27	15	34	1414021	19	60	1514021
22mm	28	29	15	34	1414022	22	60	1514022

1/2"



## 1/2" Drive 6-Point Fractional Sockets

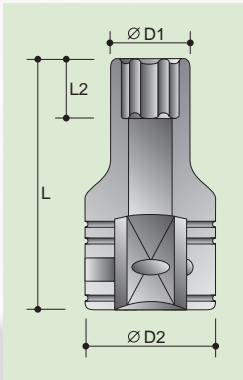

Standard



Deep

size	D2 mm	D1 mm	L2 mm	L mm	Standard Order No.	L2 mm	L mm	Deep Order No.
3/8"	22	15	6	38	1224012	13	77	1324012
7/16"	22	16.5	8	38	1224014	13	77	1324014
1/2"	22	19	9	38	1224016	13	77	1324016
9/16"	22	20.3	11	38	1224018	16	77	1324018
5/8"	22	22.8	11	38	1224020	16	77	1324020
11/16"	23	24	11	38	1224022	19	77	1324022
3/4"	25	26.5	13	40	1224024	19	77	1324024
13/16"	27	29	15	40	1224026	19	77	1324026
7/8"	28	30	15	40	1224028	22	77	1324028
15/16"	30	32.8	18	45	1224030	25	77	1324030
1"	31	34	18	45	1224100	25	77	1324100
1-1/16"	33	36.5	19	50	1224102	28	77	1324102
1-1/8"	35	39	19	50	1224104	28	77	1324104
1-3/16"	36	40	21	50	1224106	31	77	1324106
1-1/4"	38	42.8	22	50	1224108	34	77	1324108
1-5/16"	39	44	22	50	1224110	34	77	1324110
1-3/8"	40	46	22	50	1224112	34	77	1324112
1-7/16"	42	47.5	24	50	1224114	34	77	1324114
1-1/2"	44	49.5	24	50	1224116	34	77	1324116



1/2"



## 1/2" Drive 6-Point Metric Sockets

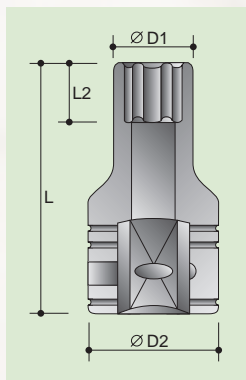

size	D2 mm	D1 mm	L2 mm	L mm	Standard Order No.	L2 mm	L mm	Deep Order No.
10mm	22	15	7	38	1024010	13	77	1124010
11mm	22	16.5	8	38	1024011	13	77	1124011
12mm	22	17.8	9	38	1024012	13	77	1124012
13mm	22	19	9	38	1024013	13	77	1124013
14mm	22	20.3	11	38	1024014	16	77	1124014
15mm	22	21.5	11	38	1024015	16	77	1124015
16mm	22	22.8	11	38	1024016	16	77	1124016
17mm	23	24	11	38	1024017	16	77	1124017
18mm	24	25	13	40	1024018	19	77	1124018
19mm	25	26.5	13	40	1024019	19	77	1124019
20mm	26	28	13	40	1024020	19	77	1124020
21mm	27	29	15	40	1024021	19	77	1124021
22mm	28	30	15	40	1024022	22	77	1124022
23mm	29	31.5	15	40	1024023	22	77	1124023
24mm	30	32.8	18	45	1024024	25	77	1124024
25mm	31	33	18	45	1024025	25	77	1124025
26mm	32	35	18	50	1024026	25	77	1124026
27mm	33	36.5	19	50	1024027	28	77	1124027
28mm	34	37.8	19	50	1024028	28	77	1124028
29mm	35	39	19	50	1024029	28	77	1124029
30mm	36	40	21	50	1024030	31	77	1124030
32mm	38	42.8	22	50	1024032	34	77	1124032
33mm	39	44	22	50	1024033	34	77	1124033
34mm	40	45	22	50	1024034	34	77	1124034
35mm	40	46	22	50	1024035	34	77	1124035
36mm	41	47	24	50	1024036	34	77	1124036



Standard



Deep

1/2"

12

## 1/2" Drive 12-Point Fractional Sockets

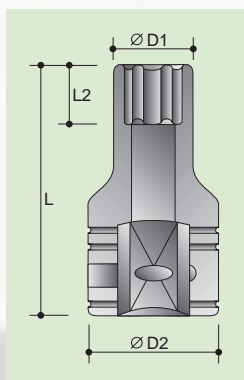

size	D2 mm	D1 mm	L2 mm	L mm	Standard Order No.	L2 mm	L mm	Deep Order No.
3/8"	22	15	6	38	1624012	13	77	1724012
7/16"	22	16.5	8	38	1624014	13	77	1724014
1/2"	22	19	9	38	1624016	13	77	1724016
9/16"	22	20.3	11	38	1624018	16	77	1724018
5/8"	22	22.8	11	38	1624020	16	77	1724020
11/16"	23	24	11	38	1624022	19	77	1724022
3/4"	25	26.5	13	40	1624024	19	77	1724024
13/16"	27	29	15	40	1624026	19	77	1724026
7/8"	28	30	15	40	1624028	22	77	1724028
15/16"	30	32.8	18	45	1624030	25	77	1724030
1"	31	34	18	45	1624100	25	77	1724100
1-1/16"	33	36.5	19	50	1624102	28	77	1724102
1-1/8"	35	39	19	50	1624104	28	77	1724104
1-3/16"	36	40	21	50	1624106	31	77	1724106
1-1/4"	38	42.8	22	50	1624108	34	77	1724108
1-5/16"	39	44	22	50	1624110	34	77	1724110
1-3/8"	40	46	22	50	1624112	34	77	1724112
1-7/16"	42	47.5	24	50	1624114	34	77	1724114
1-1/2"	44	49.5	24	50	1624116	34	77	1724116



Standard



Deep



1/2"



## 1/2" Drive 12-Point Metric Sockets

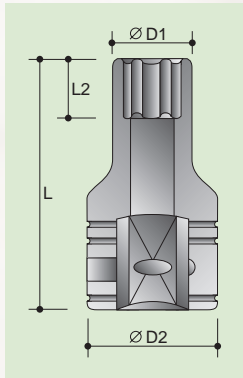

size	D2 mm	D1 mm	L2 mm	L mm	Standard Order No.	L2 mm	L mm	Deep Order No.
10mm	22	15	7	38	1424010	13	77	1524010
11mm	22	16.5	8	38	1424011	13	77	1524011
12mm	22	17.8	9	38	1424012	13	77	1524012
13mm	22	19	9	38	1424013	13	77	1524013
14mm	22	20.3	11	38	1424014	16	77	1524014
15mm	22	21.5	11	38	1424015	16	77	1524015
16mm	22	22.8	11	38	1424016	16	77	1524016
17mm	23	24	11	38	1424017	16	77	1524017
18mm	24	25	13	40	1424018	19	77	1524018
19mm	25	26.5	13	40	1424019	19	77	1524019
20mm	26	28	13	40	1424020	19	77	1524020
21mm	27	29	15	40	1424021	19	77	1524021
22mm	28	30	15	40	1424022	22	77	1524022
23mm	29	31.5	15	40	1424023	22	77	1524023
24mm	30	32.8	18	45	1424024	25	77	1524024
25mm	31	33	18	45	1424025	25	77	1524025
26mm	32	35	18	50	1424026	25	77	1524026
27mm	33	36.5	19	50	1424027	28	77	1524027
28mm	34	37.8	19	50	1424028	28	77	1524028
29mm	35	39	19	50	1424029	28	77	1524029
30mm	36	40	21	50	1424030	31	77	1524030
32mm	38	42.8	22	50	1424032	34	77	1524032
33mm	39	44	22	50	1424033	34	77	1524033
34mm	40	45	22	50	1424034	34	77	1524034
35mm	40	46	22	50	1424035	34	77	1524035
36mm	41	47	24	50	1424036	34	77	1524036





Standard

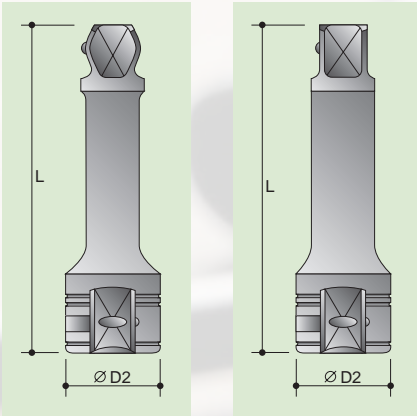

Deep

## Extension Bars



		D2	L	Wobble Extension Bar	Extension Bar
Female	Male	mm	mm	Order No.	Order No.
1/4"	1/4"	12	50		5007050
1/4"	1/4"	12	75		5007075
1/4"	1/4"	12	100		5007100
1/4"	1/4"	12	125		5007125
1/4"	1/4"	12	150		5007150
1/4"	1/4"	12	250		5007250
3/8"	3/8"	18	50		5017050
3/8"	3/8"	18	75	5016075	5017075
3/8"	3/8"	18	100		5017100
3/8"	3/8"	18	125		5017125
3/8"	3/8"	18	150	5016150	5017150
3/8"	3/8"	18	250		5017250
1/2"	1/2"	24	50		5027050
1/2"	1/2"	24	75	5026075	5027075
1/2"	1/2"	24	100		5027100
1/2"	1/2"	24	125	5026125	5027125
1/2"	1/2"	24	150	5026150	5027150
1/2"	1/2"	24	250	5026250	5027250

## Wobble Spinner Handle



Drive Size	Total Length	Order No.
1/4"	150mm	6101150





## Ratchet Handle With Quick Release



Drive Size	No. Tooth	Total Length	Order No.
1/4"	72	140	5707910
3/8"	72	200	5717910
1/2"	24	250	5727910
1/2"	24	380	5727920
1/2"	24	460	5727930

## Repair Kits

No. 8900010RK1 10 Piece 1/4" Drive Ratchet Handle With Quick Release, Repair Kit



Contents: 72 Tooth Gear Head - 1pc  
 Ratchet Pawl - 1pc  
 Ratchet Cover Plate - 1pc  
 Ratchet Reverse Pawl - 1pc  
 Set Screw - 3pcs  
 Spring - 1pc  
 Steel Ball - 1pc  
 Hex Key - 1pc

No. 8901010RK1 10 Piece 3/8" Drive Ratchet Handle With Quick Release, Repair Kit

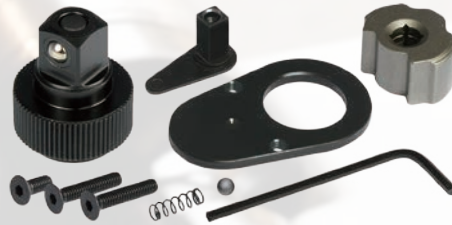

Contents: 72 Tooth Gear Head - 1pc  
 Ratchet Pawl - 1pc  
 Ratchet Cover Plate - 1pc  
 Ratchet Reverse Pawl - 1pc  
 Set Screw - 3pcs  
 Spring - 1pc  
 Steel Ball - 1pc  
 Hex Key - 1pc



No. 8902010RK1 10 Piece 1/2" Drive Ratchet Handle With Quick Release, Repair Kit



Contents: 24 Tooth Gear Head - 1pc  
 Ratchet Pawl - 1pc  
 Ratchet Cover Plate - 1pc  
 Ratchet Reverse Pawl - 1pc  
 Set Screw - 3pcs  
 Spring - 1pc  
 Steel Ball - 1pc  
 Hex Key - 1pc

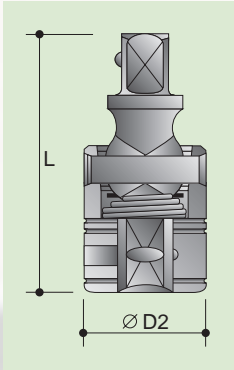

## Universal Joints

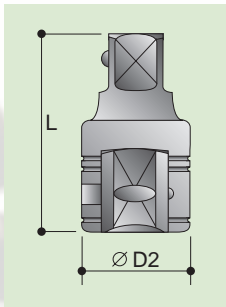

		D2	L	
Female	Male	mm	mm	Order No.
1/4"	1/4"	16	43	4800043
3/8"	3/8"	20	47	4811047
1/2"	1/2"	25	60	4822060

## Adaptors





		D2	L	
Female	Male	mm	mm	Order No.
1/4"	3/8"	13	26	4901026
3/8"	1/4"	18	32	4910032
3/8"	1/2"	18	36	4912036
1/2"	3/8"	24	38	4921038
1/2"	3/4"	25	48	4924048

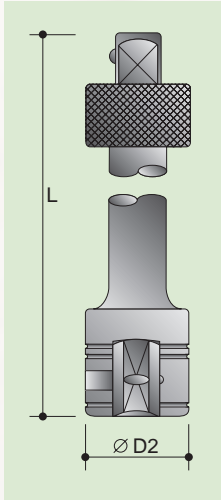

## Quick-Change Extension Bars



		D2	L	
Female	Male	mm	mm	Order No.
1/4"	1/4"	12	75	6400075
1/4"	1/4"	12	150	6400150
3/8"	3/8"	18	75	6411075
3/8"	3/8"	18	150	6411150
3/8"	3/8"	18	250	6411250
3/8"	3/8"	18	610	6411610
1/2"	1/2"	24	75	6422075
1/2"	1/2"	24	150	6422150
1/2"	1/2"	24	250	6422250
1/2"	1/2"	24	610	6422610
1/2"	1/2"	24	910	6422910

## 3/8" Drive Spark Plug Sockets

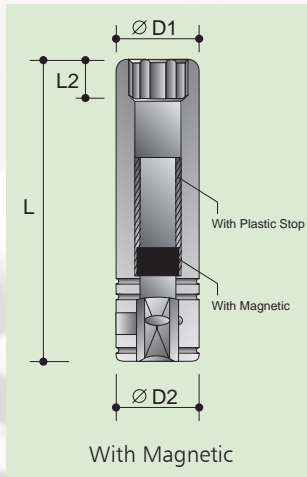
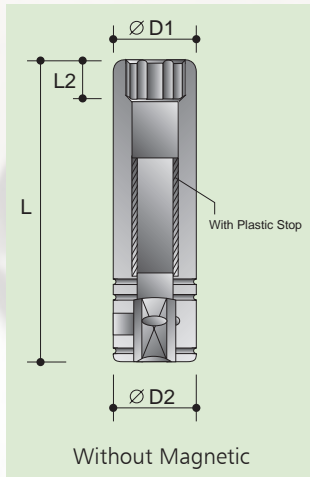

Size	D1 mm	D2 mm	L2 mm	L mm	Without Magnetic Order No.	With Magnetic Order No.
14mm	19.0	18	11	65	5116014	5117014
16mm	21.0	20	11	65	5116016	5117016
21mm	27.6	26	24	65	5116021	5117021

# ACTION



## Action: Tools For Professionals

Action Impact Sockets are specifically engineered for professional use with impact tools.

Action employs the best design, material, processes and quality control in the industry.

## Action: Best Material, Superior Process

Action Impact Sockets are made of the best material (chrome-molybdenum alloy steel) to meet the extreme requirements that professional users require from their tools. Action uses a drop forge process to form our Impact Sockets followed by precise heat and surface hardening treatments to deliver unsurpassed material strength, hardness and superior surface durability.

## Action: World Class Quality

Action Impact Sockets are World Class products which meet Federal Specifications GGG-W-660A and DIN 3121 & 3129. Our independent quality control program uses the latest technology and statistical tools to assure that each Action Socket matches World Class standards; hardness, function and torque are all spot tested. Action Impact Sockets are all warranted against defects in materials and workmanship for the life of the product.

## Action: We Have The Tools You Need

Action Impact Sockets are available in every popular drive, size and configuration including:

1/4", 3/8", 1/2", 1", 1-1/2", and 2-1/2" drives, #5 Spine drive as well as all popular sizes in SAE, Metric and Star Sockets for Torx nuts, Action also has long experience in producing special size tools based on customer specifications, samples or drawings. If the tool you needed is not in this catalog, we can make it special for you with the same quality and attention to detail that you get from all Action products.

The Specifications in this catalog are given as general information and are not binding. Due to a policy of continuous improvement, ACTION TOOLS reserves the right to modify specifications without prior notice.

# Safety Rules



THIS SYMBOL INDICATES A  
HAZARD ALERT WARNING



MANDATORY EYE  
PROTECTION

## Important Words About Safety for Users and Bystanders

These safety recommendations simply reflect good engineering practice and are not intended to be a comprehensive set of rules. They compliment, but do not replace standard precautions to be taken by every user in compliance with professional guidelines, company procedures or national regulations. Keep and follow all power tool manufacturers operating instructions and safety rules. Remember, all the rules in the world cannot replace good common sense.

- Always wear eye, face, hand and body protective equipment while using or near the use of any Impact Tool or Attachment.
- Use only Impact Sockets or Chisels that are in good condition. Worn Tools reduce impact power and could also shatter, resulting in personal injury.
- Always select the correct size and type of Tool for the job to be done.
- When using a Universal Joint, Adapter or Extension Bar, never operate the Tool off the work.
- Use only Socket Retaining Pins designed for that purpose. Never use a make-shift pin.
- Never continue to hammer with an Impact Socket once the Fastener is tight.
- Always use the simplest hook-up possible. Long Extension Bars and Adapters absorb impact power and could break loose, resulting in personal injury.
- Never modify an Impact Socket from its original design to accomplish a task for which it was not intended.
- Never strike an Impact Socket or Chisel with a Hammer or other hard object.
- Never hold a Socket, Chisel, Universal Joint or other Attachment in your hand while the Power Tool is running.
- Keep tools away from Children.

